

MARBUL RECESSED

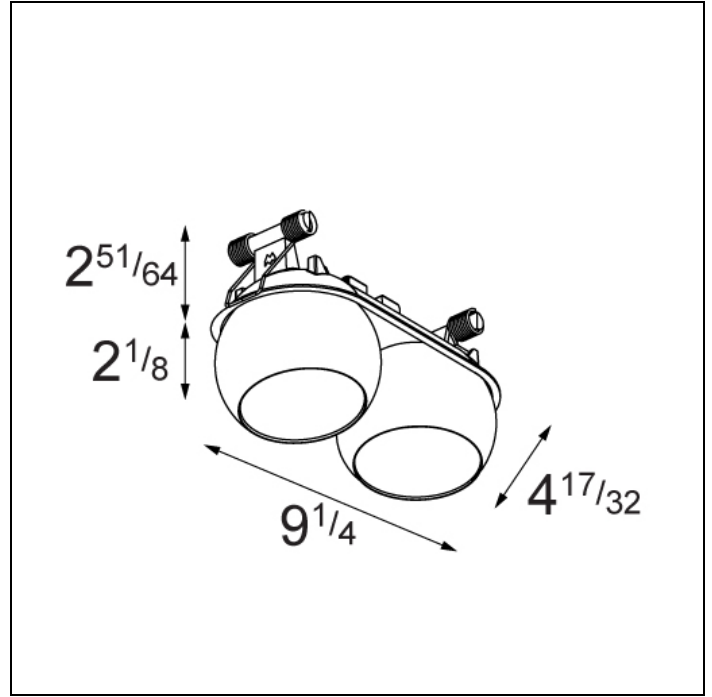

MARBUL RECESSED 4.5 2X LED DE

The iconic Marbul portfolio is specifically designed with the renovation market in mind, suiting any space and integrating into existing infrastructure with ease. Marbul recessed is characterized by a thin trim of 2" through which 1 or 2 spheres appear to hang gently from the ceiling without any visible attachments. Lamp units can be rotated 360° and inclined approximately 45°.

Art. Nr. US_14222709

SPECIFICATIONS

Lamp	2x LED Array	
Driver	driver excluded - requires housing	
Cut-out size	ø 4"1/4 (2x) 8"31/32	
Weight		
Min. distance	4 in.	
Location rating	suitable for damp locations	
Glow wire test		
webterm_lifetime	L80 B20 @ 50.000hrs	
CRI	90	
Power supply	350mA 17.3Vf	500mA 17.8Vf
webterm_connected_load	6W	8.9W
webterm_lumen	737lm	990lm
Efficacy	123lm/W	111lm/W
UGR	15	16
Adjustability	h 360° v 45°	
Remark	! must be combined with magnetic reflector ! has to be used with appropriate housing ! JA8 certified	

	WARM WHITE 2700K / CRI 90+	WARM WHITE 3000K / CRI 90+	NEUTRAL WHITE 3500K / CRI 90+
black struc	US_14222232	US_14222332	US_14222732
donkey grey struc	US_14222276	US_14222376	US_14222776
white struc	US_14222209	US_14222309	US_14222709

